

LUXEN

LUXHYPER[®]

MONO

320-340w

LUXHYPER[®] series (Super-efficiency half-cell Modules) Assembled with the advanced half-cell technology offer the advantages of higher power output, reduced series resistance loss, and lower risk of hot spot. In order to meet the Clients' requirements of best quality and efficiency.

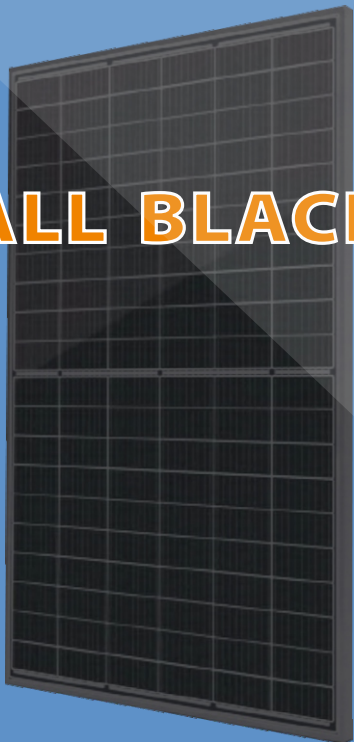

120 cells
Half-Cell Modules

ALL BLACK

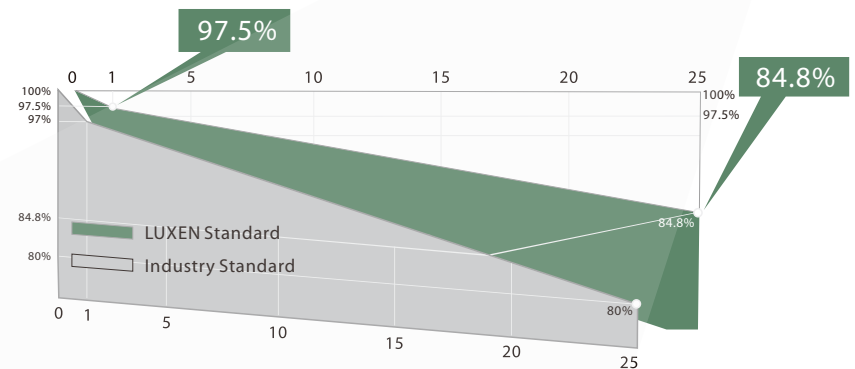

LINEAR PERFORMANCE WARRANTY



- 9BB** 9BB cell design
Smaller electric current, less CTM loss
Lower risk of hot spot
-  ISO9001:2015 QMS
ISO14001:2015 EMS
ISO45001:2018 OHSMS
- IEC** IEC61215&IEC61730
standard quality
-  Wind load up to 3800Pa
Snow load up to 5400Pa
- +5W** 0-5W positive power sorting
-  Stable performance under
weak light conditions
- 25-year
12-year** 25-year power warranty
12-year product warranty



MONO 320-340w 120 cells 9BB ALL BLACK

LUXEN

ELECTRICAL PARAMETERS

| | LNSK-320M | | LNSK-325M | | LNSK-330M | | LNSK-335M | | LNSK-340M | |
|--------------------------------|-----------|--------|-----------|--------|-----------|--------|-----------|--------|-----------|--------|
| | STC | NOCT | STC | NOCT | STC | NOCT | STC | NOCT | STC | NOCT |
| Maximum Power (Pmax) | 320W | 238W | 325W | 242W | 330W | 246W | 335W | 250W | 340W | 254W |
| Open Circuit Voltage (Voc) | 40.46V | 37.67V | 40.78V | 38.00V | 41.07V | 38.38V | 41.37V | 38.72V | 41.67V | 39.06V |
| Short Circuit Current (Isc) | 10.17A | 8.15A | 10.24A | 8.21A | 10.32A | 8.26A | 10.39A | 8.32A | 10.47A | 8.37A |
| Voltage at Maximum Power (Vmp) | 33.54V | 33.43V | 33.78V | 33.70V | 34.06V | 34.02V | 34.30V | 34.31V | 34.55V | 34.60V |
| Current at Maximum Power (Imp) | 9.54A | 7.12A | 9.62A | 7.18A | 9.69A | 7.23A | 9.77A | 7.29A | 9.84A | 7.34A |
| Module Efficiency(%) | 18.96% | | 19.26% | | 19.56% | | 19.85% | | 20.15% | |

STC: Irradiance 1000W/m², cell temperature 25°C, AM1.5G
NOCT: Irradiance 800W/m², ambient temperature 20°C, wind speed 1m/s, AM1.5G

LNSK-330M/I-V

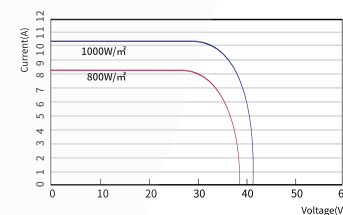

| | |
|--|----------------|
| Operating Module Temperature | -40°C to +85°C |
| Maximum System Voltage | 1500V DC(IEC) |
| Maximum Series Fuse Rating | 20A |
| Power Tolerance | 0/+5W |
| Temperature Characteristics | |
| Nominal Operating Cell Temperature(Noct) | 45±2°C |
| Temperature Coefficient of Pmax | -0.36%/°C |
| Temperature Coefficient of Voc | -0.28%/°C |
| Temperature Coefficient of Isc | +0.05%/°C |

Packing Configuration

| | 20'GP | 40'HQ |
|-----------------------|-------|-------|
| Pieces per pallet | 31 | 31 |
| Pallets per container | 12 | 26 |
| Pieces per container | 372 | 806 |

Mechanical Characteristics

| | |
|----------------------|---|
| Solar Cell | MONO158.75x79.375mm |
| No.of Cell | 120(6x20) |
| Dimensions | 1684x1002x35mm |
| Weight | 19.0kgs |
| Front | 3.2mm coated tempered glass |
| Frame | Anodized aluminium alloy |
| Junction Box | Ip68 rated(3 by pass diodes) |
| Output Cables | 4.0mm ² 300mm(+)/300mm(-) Length can be customized |
| Connectors | MC4 compatible |
| Mechanical load test | 5400Pa |

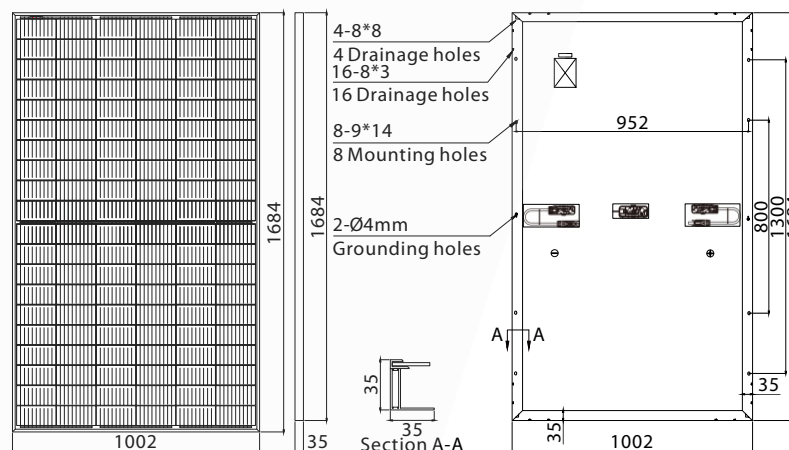

LUXEN SOLAR ENERGY CO., LTD
 T:+86 512 6708 1572
 F:+86 512 6708 1570
 sales@luxensolar.com
 www.luxensolar.com

Note: Due to continuous technical innovation, R&D and improvement, technical data above mentioned may be of modification accordingly. LUXEN SOLAR have the sole right to make such modification at anytime without further notice.

