

LUXPOWER® SERIES 5 575-595W Mono

M10/182mm Cell . 156 Half-Cell Layout

LUXPOWER® Series 5 solar modules stand out with the breakthrough innovation of M10 size (182mm) solar cells for the highest power generation and the lowest LCOE, which makes Series 5 the optimal choice for large solar power plants. The gallium-doped wafer technology empowers significantly the performance against LID and the latest integrated segmented ribbon technology increases the power output and enhances the module reliability for long-term use.



Gallium-doped Technology



Half Cut Cell Technology



MBB Technology



Anti-PID
Low LID
Performance



Less Hot Spot
Shading Effects



Lower BOS & LCOE

Linear performance Warranty

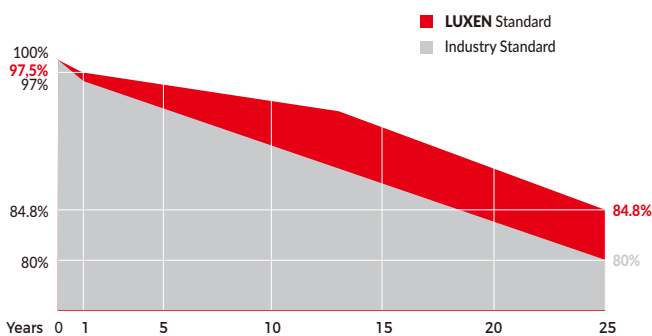

Comprehensive Certificates

- ISO9001:2015 QMS
- ISO14001:2015 EMS
- ISO45001:2018 OHSMS
- IEC61215/IEC61730 Standard quality



MECHANICAL CHARACTERISTICS

Solar Cells	Mono
No. of Cells	156 (6x26)
Dimensions	2465 x 1134 x 35mm
Weight	30.0kgs
Front Glass	3.2mm coated tempered glass
Frame	Anodized aluminium alloy
Junction Box	Ip68 rated (3 by pass diodes)
	4.0mm ²
Output Cables	300mm (+) / 400mm (-)
	Length can be customized
Connectors	Mc4 compatible
Mechanical load test	5400Pa

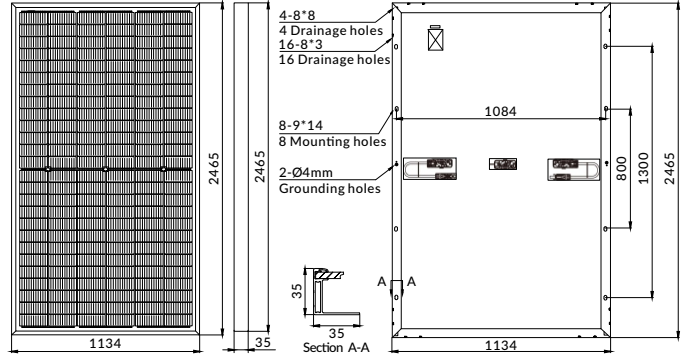

ELECTRICAL PARAMETERS

POWER CLASS	LNVH-575M		LNVH-580M		LNVH-585M		LNVH-590M		LNVH-595M	
	STC	NOCT	STC	NOCT	STC	NOCT	STC	NOCT	STC	NOCT
Maximum power (Pmax)	575W	437W	580W	441W	585W	445W	590W	449W	595W	453W
Open Circuit Voltage (Voc)	50.45V	49.25V	50.66V	49.47V	50.84V	49.69V	51.02V	49.91V	51.21V	50.13V
Short Circuit Current (Isc)	14.41A	11.27A	14.46A	11.31A	14.52A	11.35A	14.57A	11.39A	14.63A	11.43A
Voltage at Maximum power (Vmpp)	43.04V	41.03V	43.19V	41.25V	43.33V	41.47V	43.48V	41.69V	43.62V	41.91V
Current Maximum Power (Impp)	13.36A	10.65A	13.43A	10.69A	13.50A	10.73A	13.57A	10.77A	13.64A	10.81A
MODULE EFFICIENCY (%)	20.57%		20.75%		20.93%		21.11%		21.29%	

STC: Irradiance 1000W/m², cell temperature 25°C, AM1.5G NOCT: Irradiance 800W/m², ambient temperature 20°C, wind speed 1m/s, AM1.5G

PACKING CONFIGURATION

Container	20'GP	40'HQ
Pieces per pallet	31	31
Pallets per container	4	16
Pieces per container	124	496

I-V CURVE

LNVH-585M/I-V

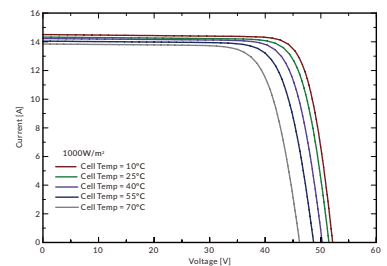
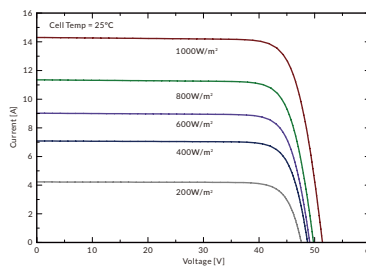

OPERATING CHARACTERISTICS

Operating Module Temperature	-40°C to + 85°C
Maximum System Voltage	1500 DC (IEC)
Maximum Series Fuse Rating	25A
Power Tolerance	0/+5W

TEMPERATURE CHARACTERISTICS

Nominal Operating Temperature (Noct)	45±2°C
Temperature Coefficient of Pmax	-0.36%/°C
Temperature Coefficient of Voc	-0.28%/°C
Temperature Coefficient of Isc	+0.05%/°C

Note: Due to continuous technical innovation, R&D and improvement, technical data above mentioned may be of modification accordingly. LUXEN SOLAR have the sole right to make such modification at anytime without further notice.